



**Product Code**

**VP33522**



**63A 2P+E Angled Wall Socket IP67**

★ Rated current:63A
★ Rated voltage: 220-250V
★ No. of poles:2P+E
★ Protection degree: IP67
★ Housing material: Flame Retardant PA6 RoHS Reach Contact: nickel-plated brass RoHS Reach
★ Standards: IEC60309-1, IEC60309-2
★ Certificates: S,CB,CE,TUV,ISO9001:2008,RoHS,REACH

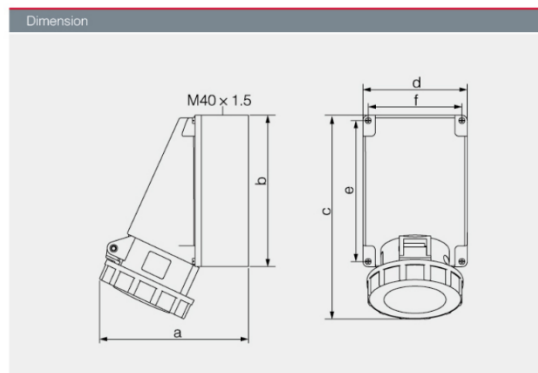

Current Pole	63A			125A		
	3	4	5	3	4	5
a	171	171	171	165	165	165
b	170	170	170	230	230	230
c	230	230	230	330	330	330
d	118	118	118	160	160	160
e	135	135	135	240	240	240
f	105	105	105	160	160	160
Cable size(mm <sup>2</sup> )	6~25			25~70		

